

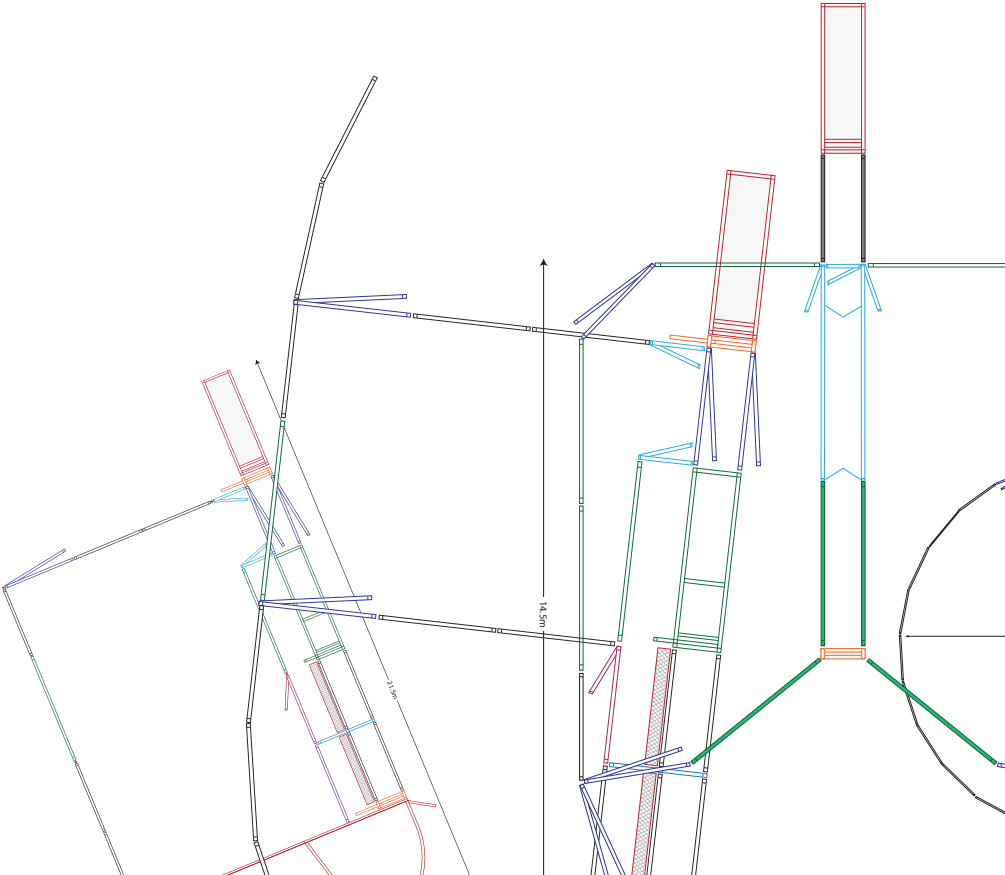

BRAZZEN

RURAL PRODUCTS



YARD DRAWINGS







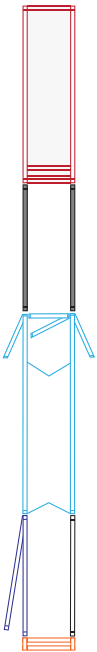

Display Yard Samples

All Yards Are Available in Offside Setup









SHEEP

KIT INCLUDES:

Sheep Loading Ramp		1
Adjustable V-Race		1
Guillotine Gate		1
Sheep Gate 2.0		1
Sheep Panels 2.0		1
Sheep Panels 2.0 Blind		2

CATTLE

KIT INCLUDES:

Cattle Loading Ramp		1
Sliding Gate		1
Cattle Gate 2.1		2
Cattle Crush		1
Cattle Panel 2.1		2
Blind Force Yard		1

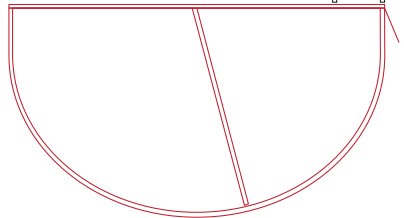
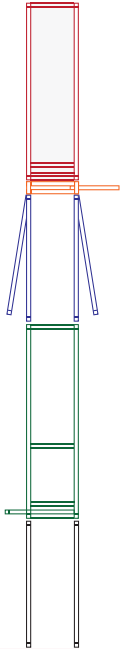



HOW TO RECOGNISE YOU ARE BUYING BRAZZEN GENUINE EQUIPMENT



BRAZZEN, OVER THE YEARS HAS BECOME A DOMINANT PLAYER IN THE LIVESTOCK EQUIPMENT INDUSTRY.

- 1 We pride ourselves in having excellent galvanising and even our upright posts are hot dipped galvanised on all our panels which is important as this is the part that touches the ground.
- 2 All the gauges/tube wall thickness of our rails and posts are exactly the thickness as stated in our specifications.
- 3 Our workers pride themselves in their welding and you will see the difference with our welding compared with our competitors.
- 4 All our equipment has the anti-rattle rubbers where the pins join the equipment.
- 5 Our standard cattle panels are 36kg in weight, the biggest deception with cheaper panels is the thin steel tube gauge which reflects in the weight of steel.
- 6 Some companies have cheap panels with only half a C clamp on one side to save on steel. When linked with other panels this is much weaker than the full C clamp. Beware of these inferior panels.



"If it is not Genuine Brazen there is no Brazen Warranty"

The factory manufacturing is controlled by Australians and so the quality control and the development are all looked after by Australians. Australia Livestock Equipment is known to be the most robust equipment throughout the world and a lot of Brazen equipment is used in the Northern Territory and the outback where buffalos and wild cattle and horses are penned and captured in Brazen Equipment.

We now have a lot of manufacturers starting to copy our equipment and trying to sell them as Brazen Equipment.

For you to recognise genuine Brazen Equipment, you will see a logo on the cap on the top of the posts on our panels, you will see a Brazen sticker on the panels. A lot of our equipment will have the logo stamped in them.

If you have a farm and would like to make another income we are looking for dealers. Reach out if this is something you are interested in.

Do please keep buying Brazen Equipment and make sure it is genuine.

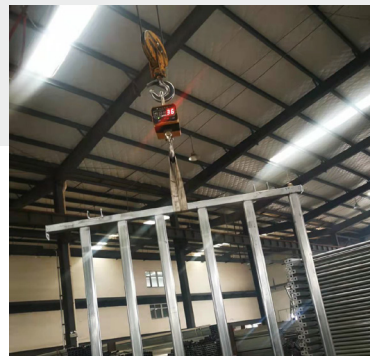

BE BRAZEN BUY BRAZZEN



Yard Plan for 10+

KIT INCLUDES:



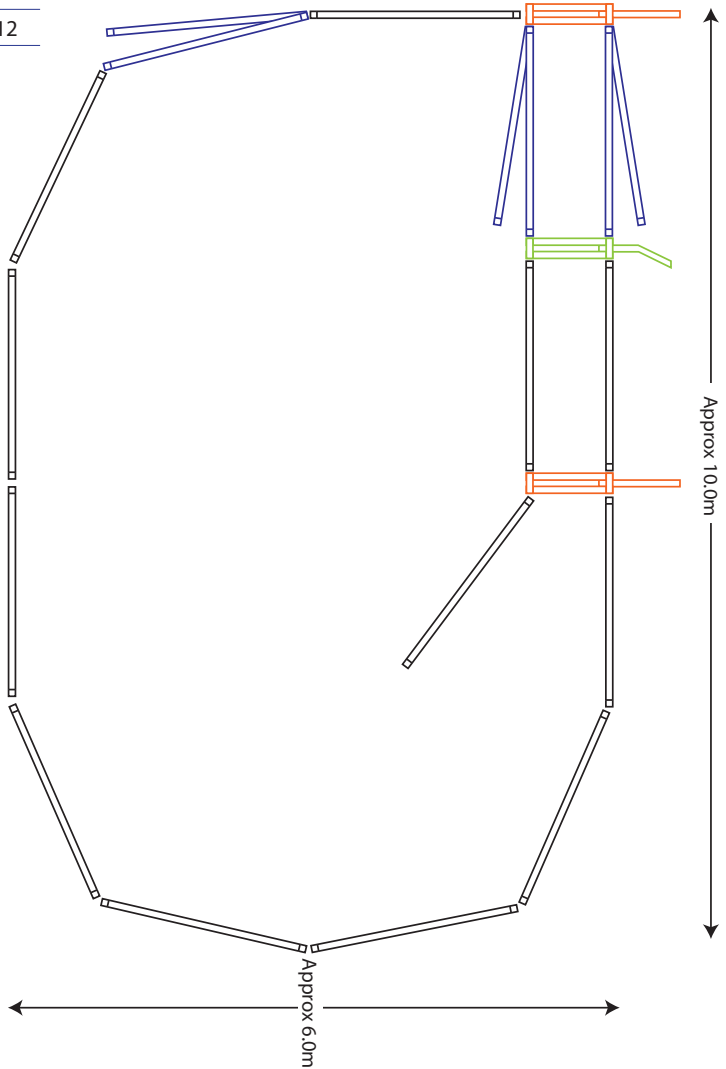



Sliding Gates	■	2
Standard Gates	■	3
Head Bale	■	1
Budget Panels	■	12





Yard Plan for 10-15 Small Force

KIT INCLUDES:

Head Bale		1
Loading Ramp		1
Sliding Gates		2
Standard Gates		4
Panel 2.1		12
Panel 3.35		1

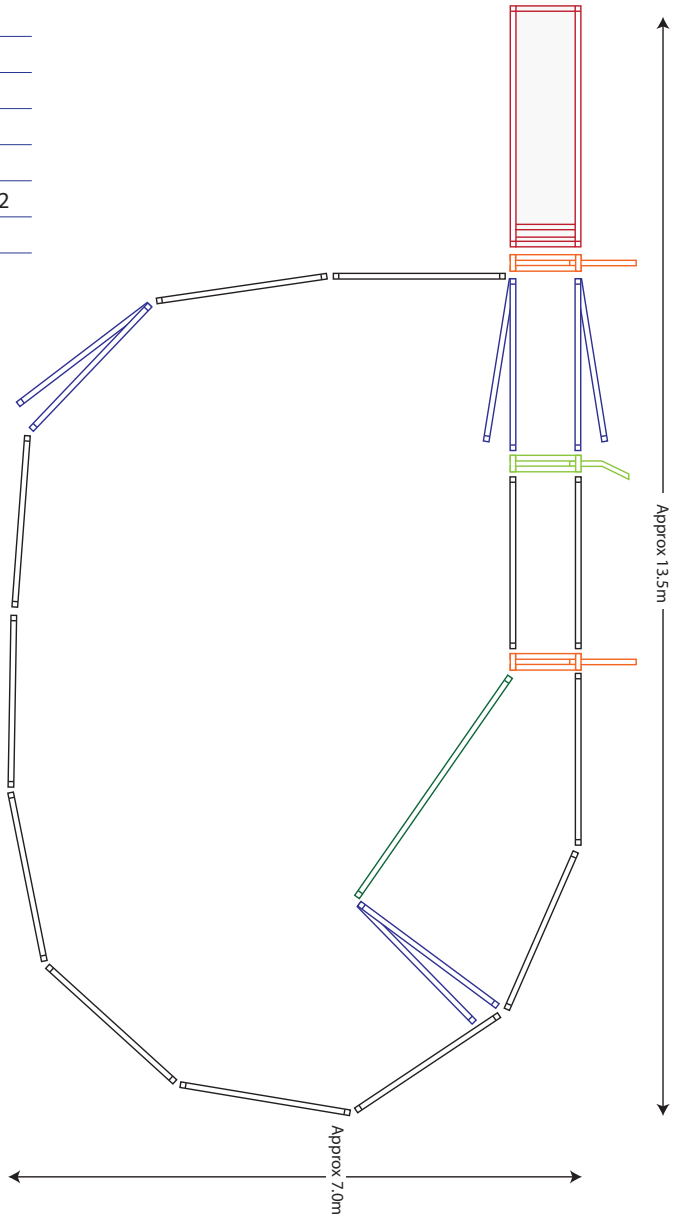



Yard Plan for 20-30 Force

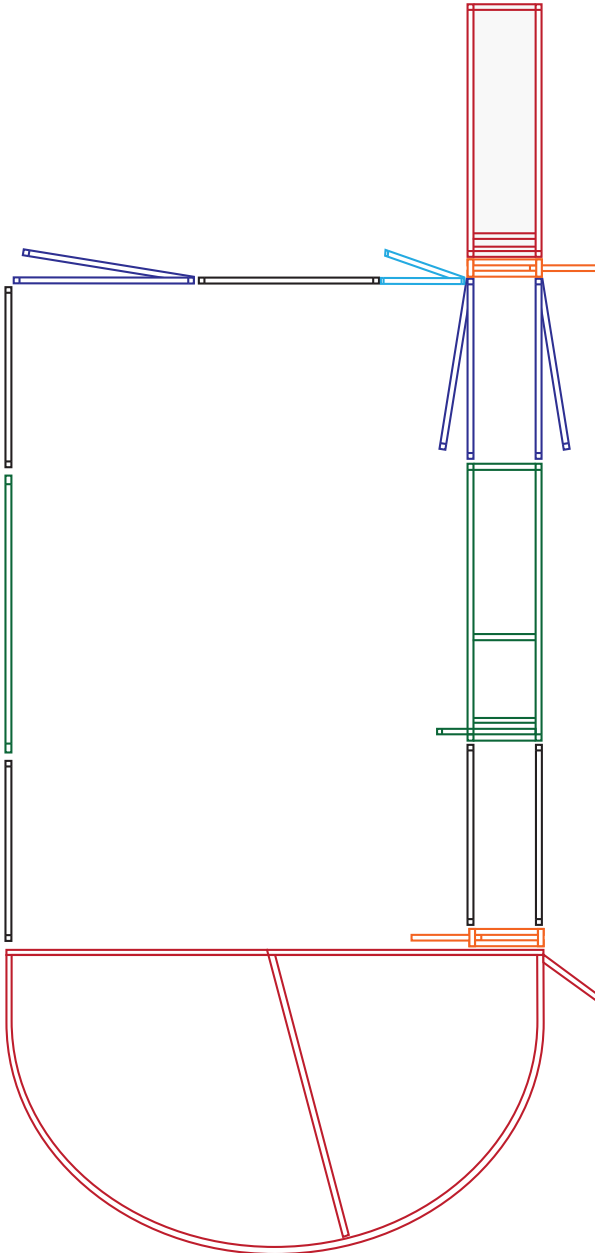







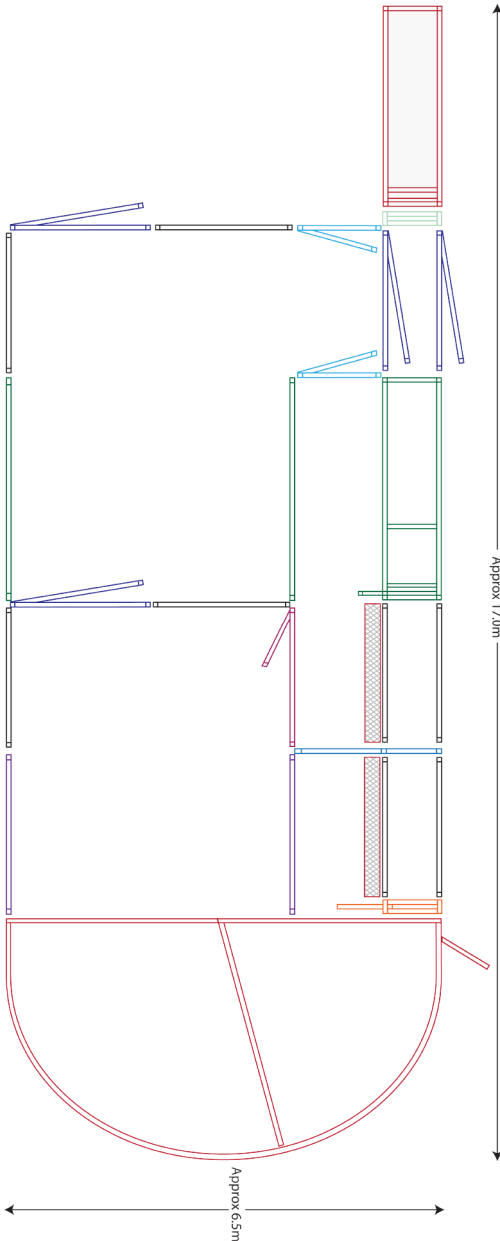





KIT INCLUDES

Loading Ramp	■	1
Cattle Crush	■	1
Force Yard	■	1
Sliding Gates	■	2
Standard Gates	■	3
Access Gate	■	1
Standard Panels	■	5
3.35 Panel	■	1

Yard Plan for 30-40 Force

KIT INCLUDES:

Loading Ramp		1
Cattle Crush		1
Force Yard		1
Sliding Gates		1
Race Gates		1
Cattle Gates 2.1		4
Access Gate		2
Cattle Panels 2.1		8
Cattle Panels 2.4		2
Cattle Panels 3.3		2
Man Panel Gate		1
Walkway Race Bow		1
Race Walkway Mesh		2



Yard Plan for 40-50 Force

KIT INCLUDES

Loading Ramp	■	1
Cattle Crush	■	1
Force Yard	■	1
Sliding Gates	■	2
Standard Gates	■	4
Access Gate	■	2
Standard Panels 2.1	■	13
Standard Panels 2.4	■	1
Standard Panels 3.3	■	2
Man Panel Gate	■	1
Double Race Bow	■	2
Race Walkway Mesh	■	2

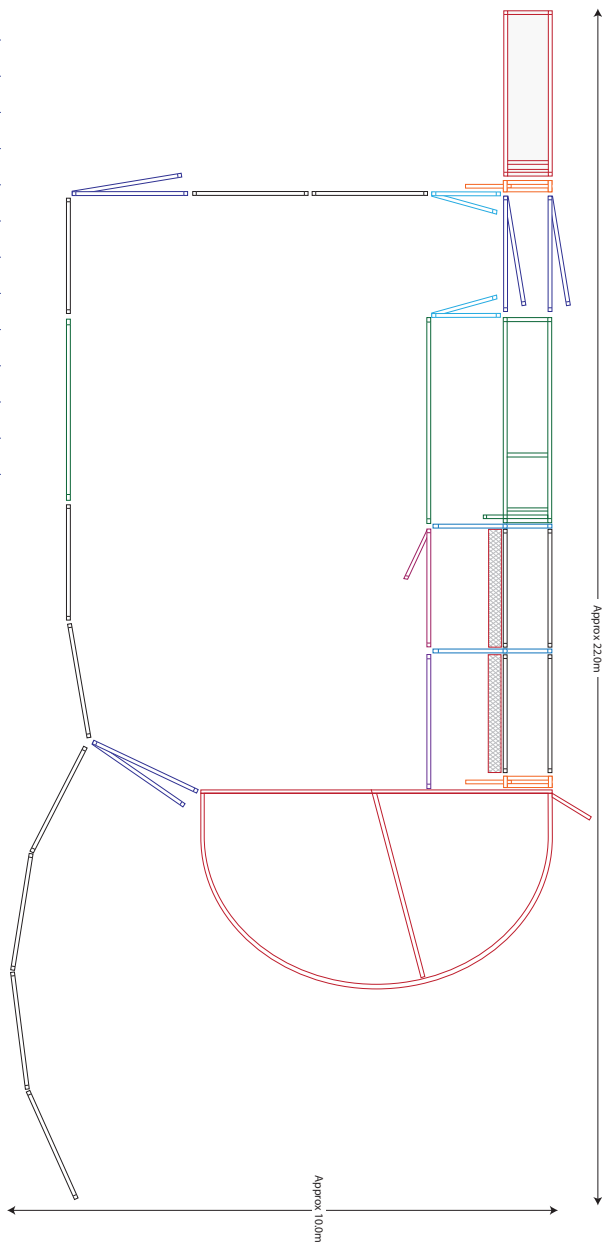



Yard Plan for 50-60 Force

KIT INCLUDES

Loading Ramp	■	1
Cattle Crush	■	1
Force Yard	■	1
Sliding Gates	■	2
Standard Gates	■	4
Access Gate	■	3
Standard Panels 2.1	■	17
Standard Panels 2.4	■	1
Standard Panels 3.3	■	2
Man Panel Gate	■	1
Race Bow	■	3
Race Walkway Mesh	■	3

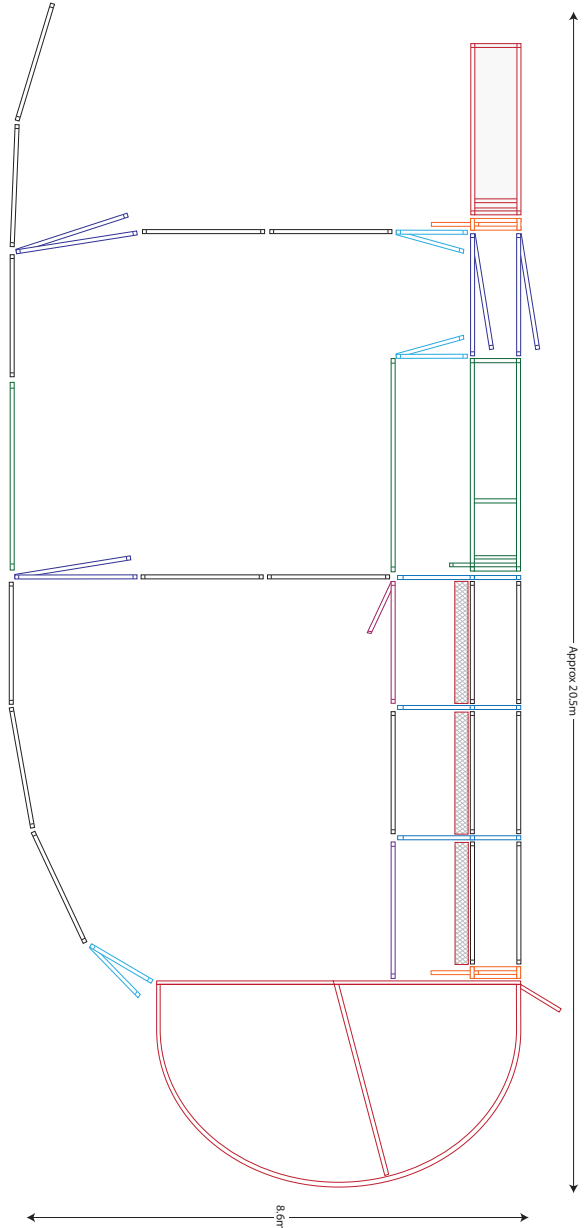

Yard Plan for 60+ Force

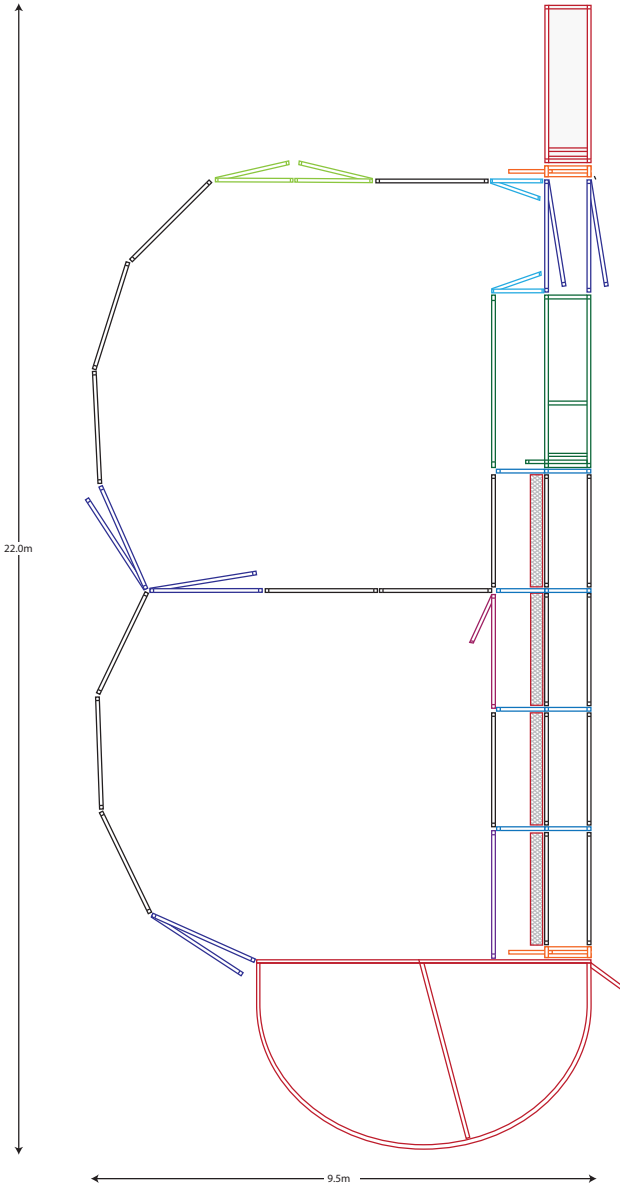
KIT INCLUDES:

Loading Ramp	■	1
Cattle Crush	■	1
Force Yard	■	1
Sliding Gates	■	2
Standard Gates 2.1	■	5
Access Gate 1.25	■	2
Double Gate 3.0	■	1
Standard Panels 2.1	■	19
Standard Panels 2.4	■	1
Standard Panels 3.3	■	1
Man Panel Gate	■	1
Race Walkway Bow	■	4
Race Walkway Mesh	■	4



Yard Plan for 70+ Force

KIT INCLUDES:

Loading Ramp	■	1
Cattle Crush	■	1
Force Yard	■	1
Sliding Gates	■	2
Standard Gates 2.1	■	4
Access Gate 1.25	■	2
Double Gate 3.0	■	1
Standard Panels 2.1	■	18
Standard Panels 2.4	■	1
Standard Panels 3.3	■	1
Man Panel Gate	■	1
Race Walkway Bow	■	3
Race Walkway Mesh	■	3

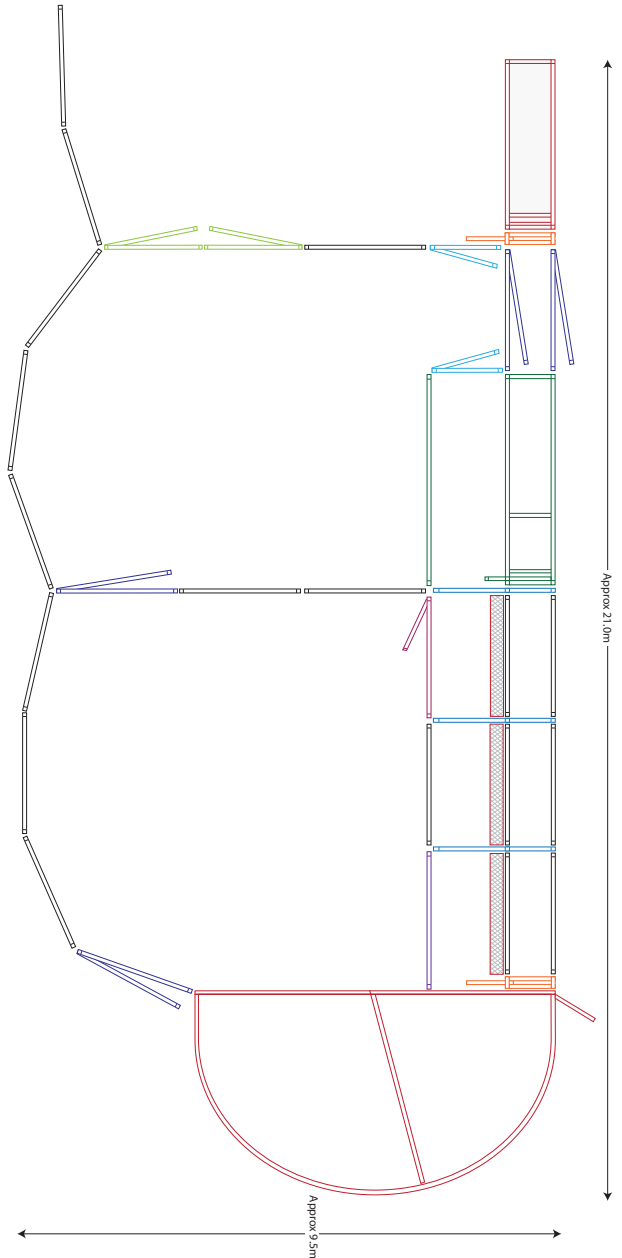



Yard Plan for 70+ Worker Force Yard

KIT INCLUDES:

Loading Ramp	■	1
Cattle Crush	■	1
Force Yard	■	1
Sliding Gates	■	2
Cattle Gates 2.1	■	6
Access Gate	■	2
Cattle Panels 1.25	■	1
Cattle Panels 2.1	■	24
Cattle Panels 2.4	■	1
Cattle Panels 3.3	■	1
Man Panel Gate	■	1
Walkway Race Bow	■	3
Race Walkway Mesh	■	4

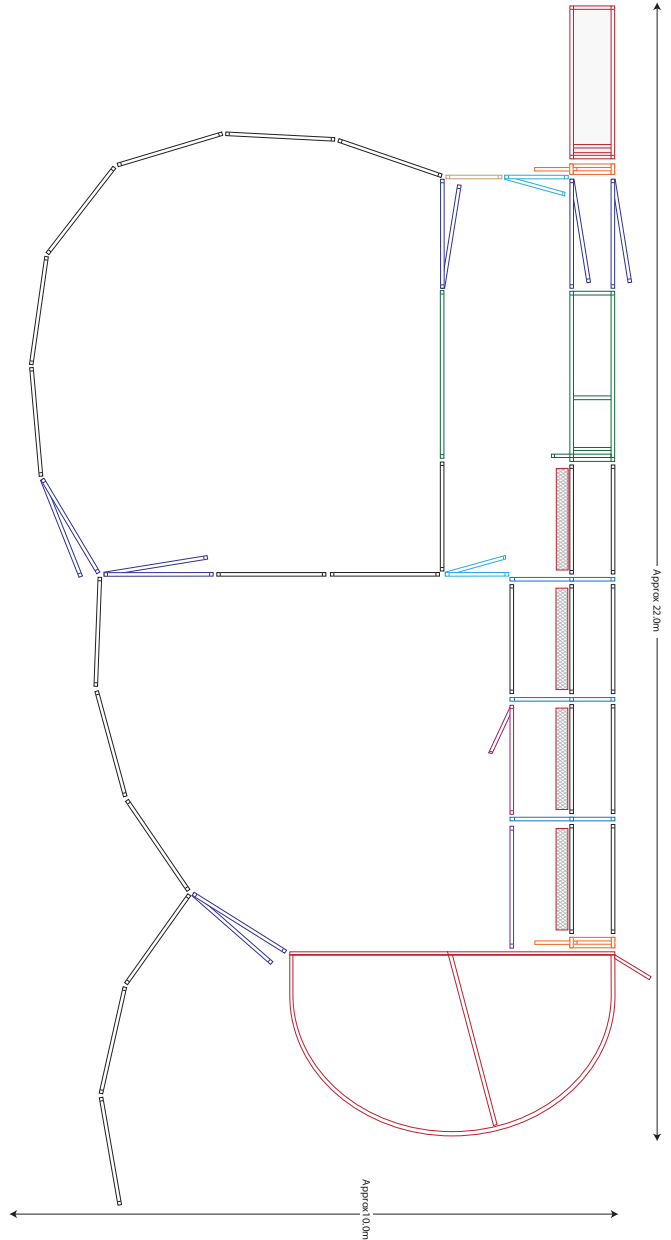



Yard Plan for 60-80 Head of Cattle

KIT INCLUDES:

Loading Ramp	■	1
Cattle Crush	■	1
Sliding Gates	■	2
Standard Gates	■	7
Standard Panels	■	25
Race Bow	■	1

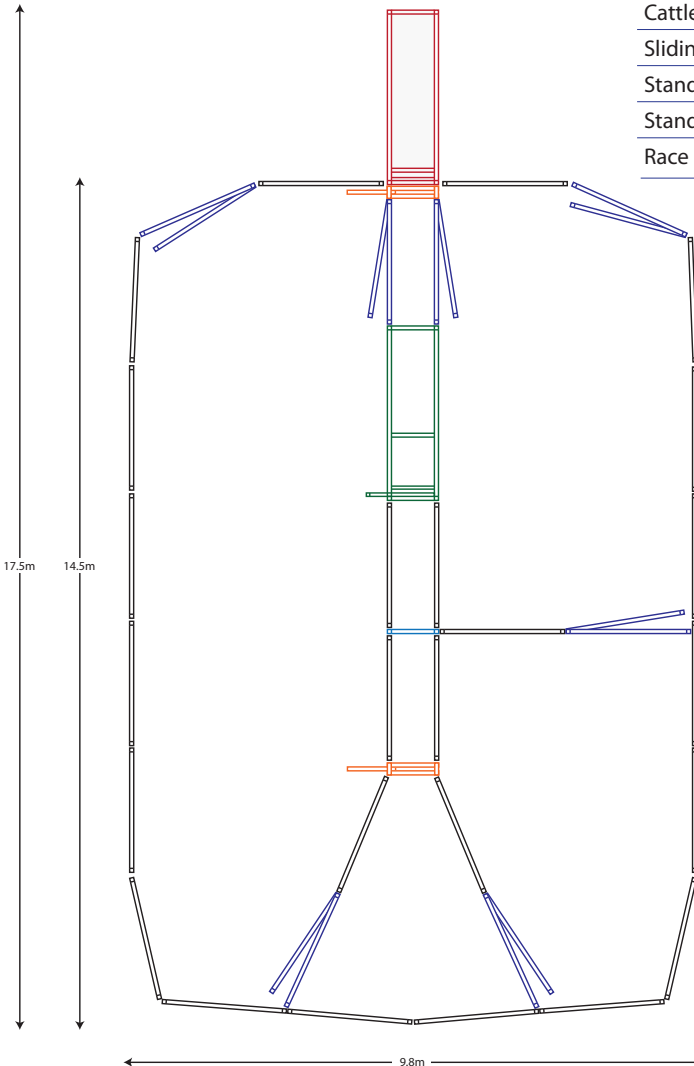



Yard Plan for 80+ Force

KIT INCLUDES

Loading Ramp	■	1
Cattle Crush	■	1
Force Yard	■	1
Sliding Gates	■	2
Standard Gates	■	6
Access Gate 1.25	■	3
Standard Panels 2.1	■	24
Standard Panels 2.4	■	2
Standard Panels 3.35	■	3
Standard Man Panel	■	1
Race Bow	■	3
Race Walkway Mesh	■	3

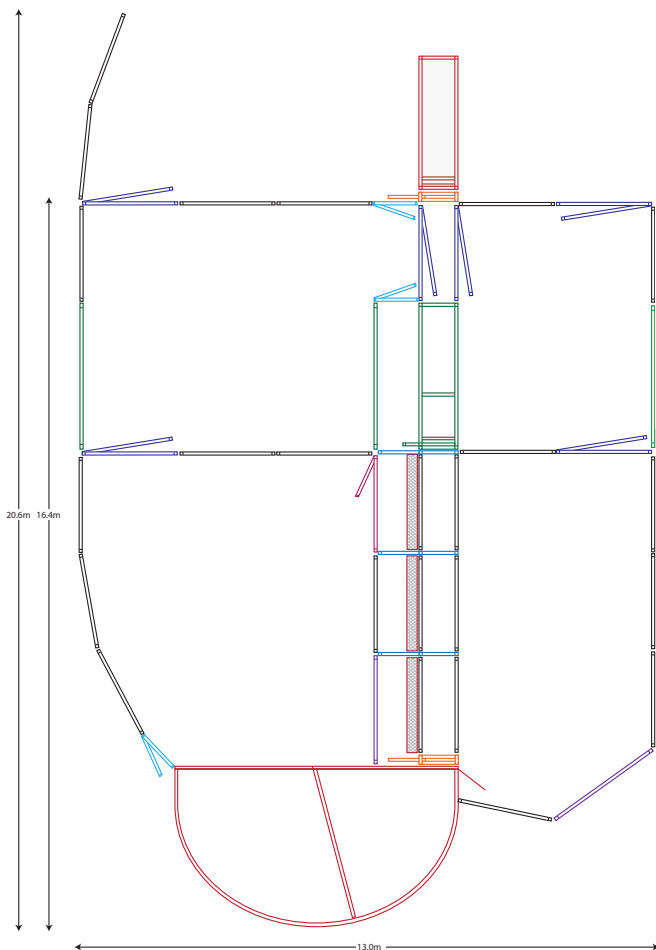



Yard Plan for 150+ Curved Race

KIT INCLUDES:

Loading Ramp	■	1
Cattle Crush	■	1
Sliding Gates	■	2
Standard Gates	■	11
Standard Double Gate	■	1
Access Gate	■	1
Standard Panels 2.1	■	51
Standard Panels 2.4	■	14
Standard Panels 3.35	■	1
Race Bow	■	9

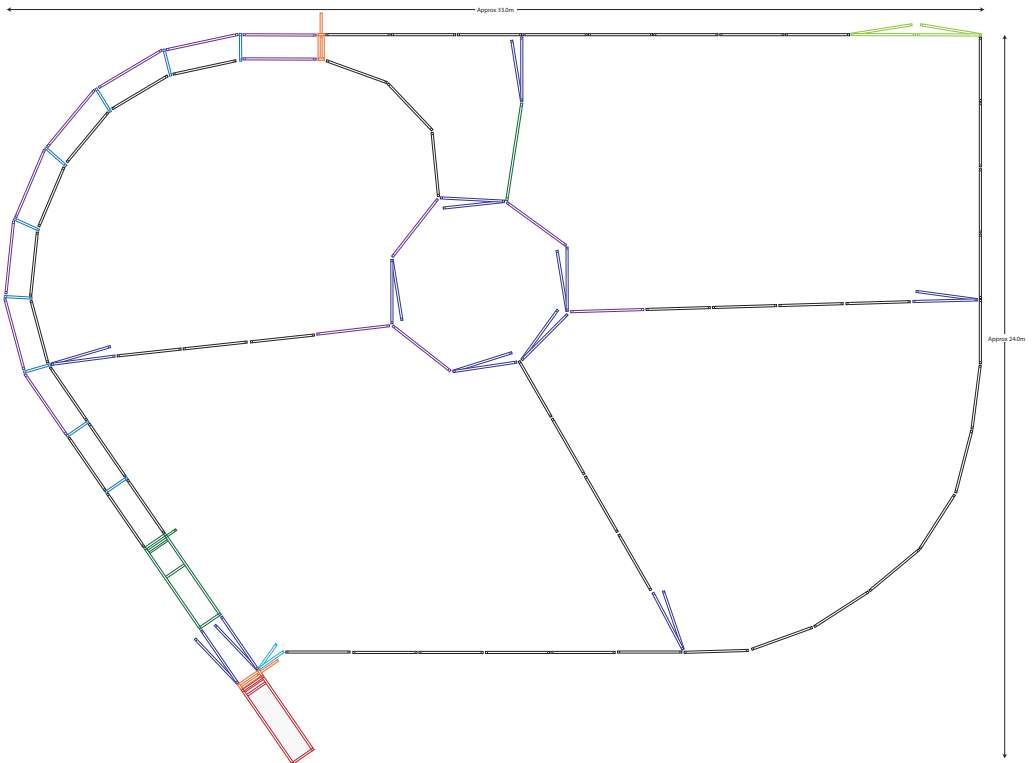



Yard Plan for Wean Yard

KIT INCLUDES

Loading Ramp	■	1
Cattle Crush	■	1
Sliding Gates	■	2
Standard Gates	■	12
Standard Double Gate	■	1
Access Gate	■	1
Standard Panels 2.1	■	51
Standard Panels 2.4	■	8
Race Bow	■	3

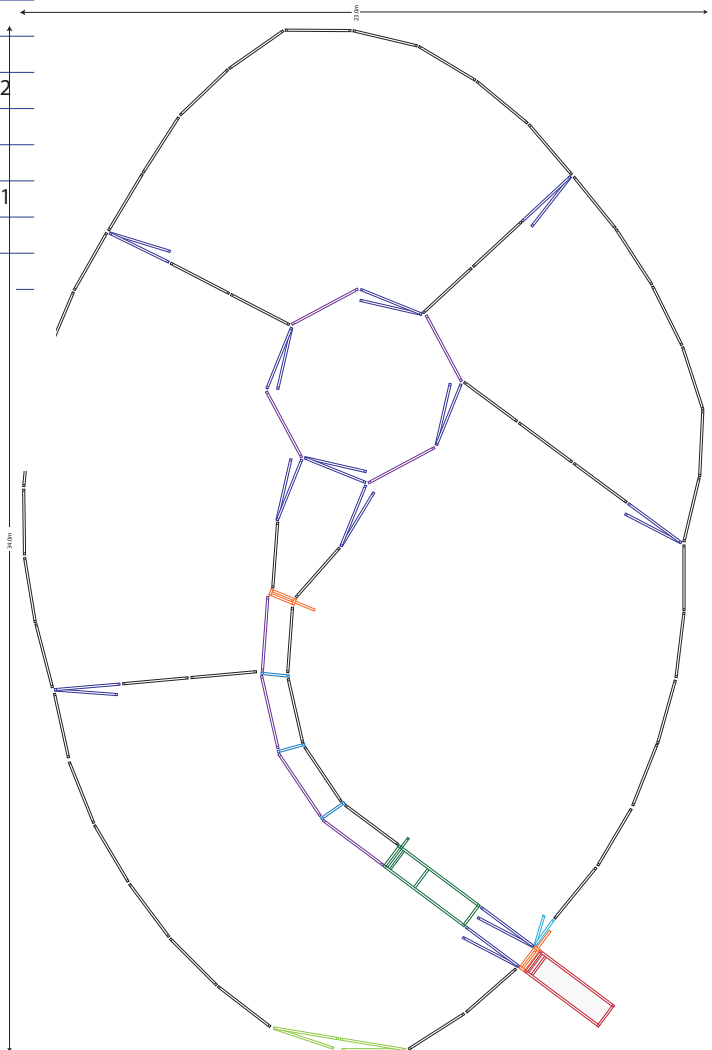



Yard Plan for 100+ Flow Yard

KIT INCLUDES

Loading Ramp	■	1
Cattle Crush	■	1
Sliding Gates	■	2
Standard Gates	■	5
Access Gate	■	1
Standard Panels 2.1	■	33
Standard Panels 2.4	■	4
Race Bow	■	4
Force Yard	■	1
3m Gates	■	8
3.35 Panels	■	3

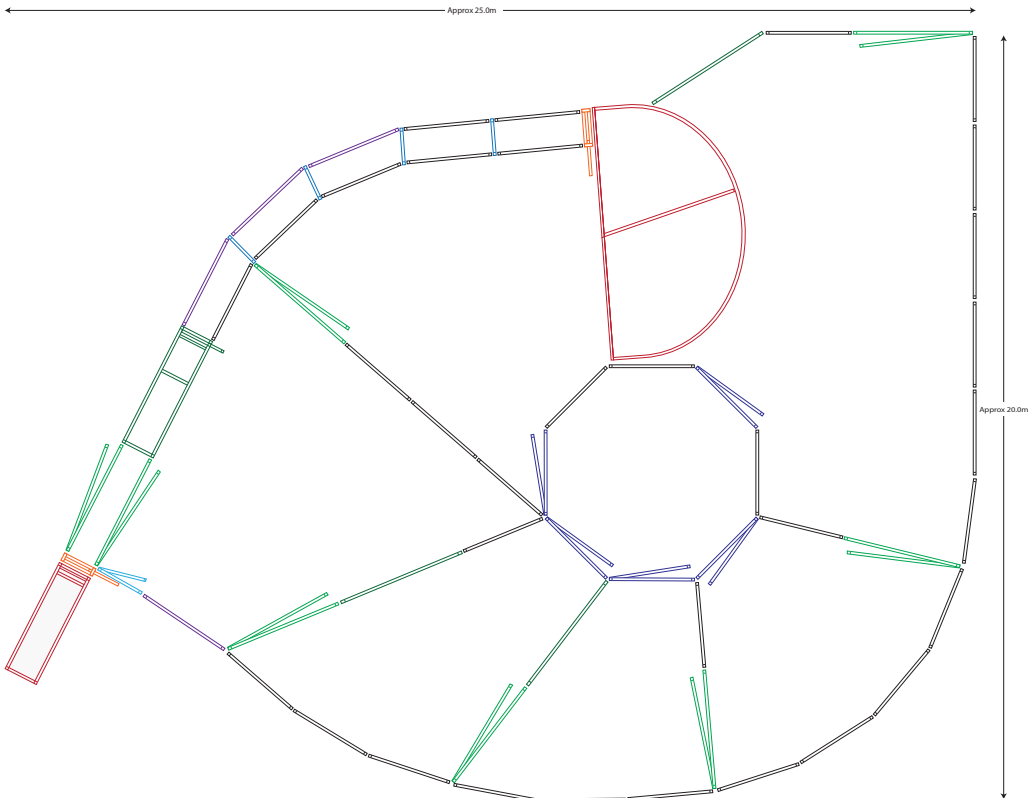



Yard Plan for 100+ Force

KIT INCLUDES

Loading Ramp	■	1
Cattle Crush	■	1
Force Yard	■	1
Sliding Gates	■	2
Standard Gates	■	7
Double 3.0m Gate	■	1
Access Gate	■	2
Standard Panels 2.1	■	44
Standard Panels 2.4	■	1
Standard Panels 3.35	■	1
Man Panel Gate	■	1
Race Walkway Bow	■	4
Race Walkway Mesh	■	4

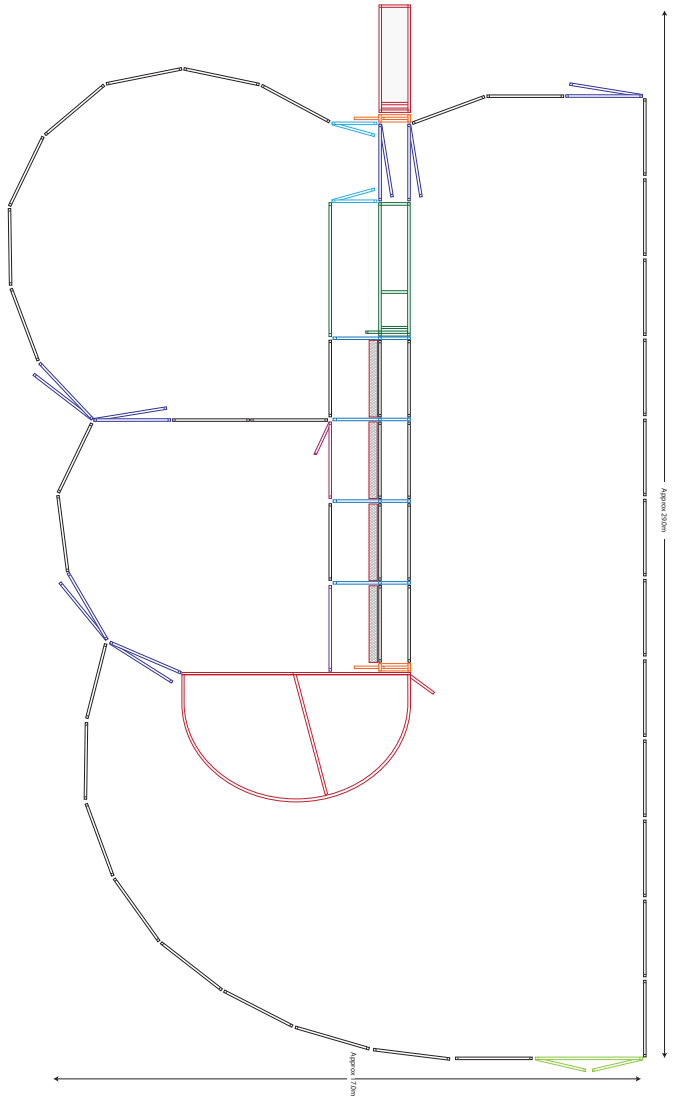



Yard Plan for 200-250 Force

KIT INCLUDES:

Loading Ramp	■	1
Cattle Crush	■	1
Force Yard	■	1
Sliding Gates	■	2
Cattle Gates 2.1	■	8
Cattle Gates 3.0	■	4
Access Gate	■	2
Cattle Panels 2.1	■	67
Cattle Panels 2.4	■	1
Cattle Panels 3.3	■	1
Man Panel Gate	■	1
Walkway Race Bow	■	4
Race Walkway Mesh	■	4

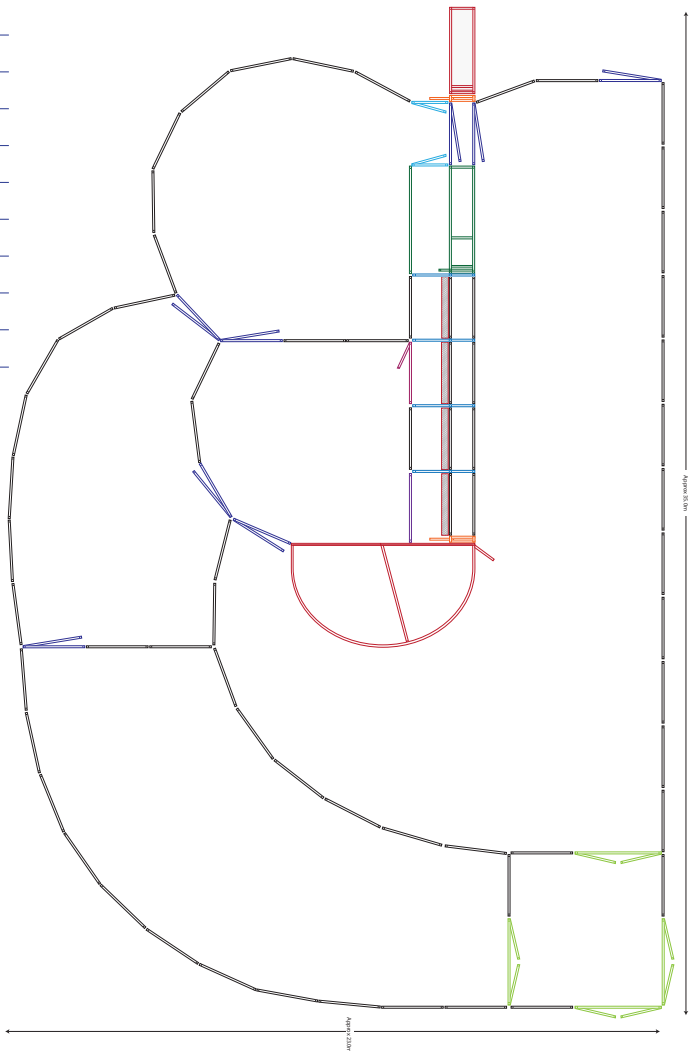

Yard Plan for 20-30 Sheep



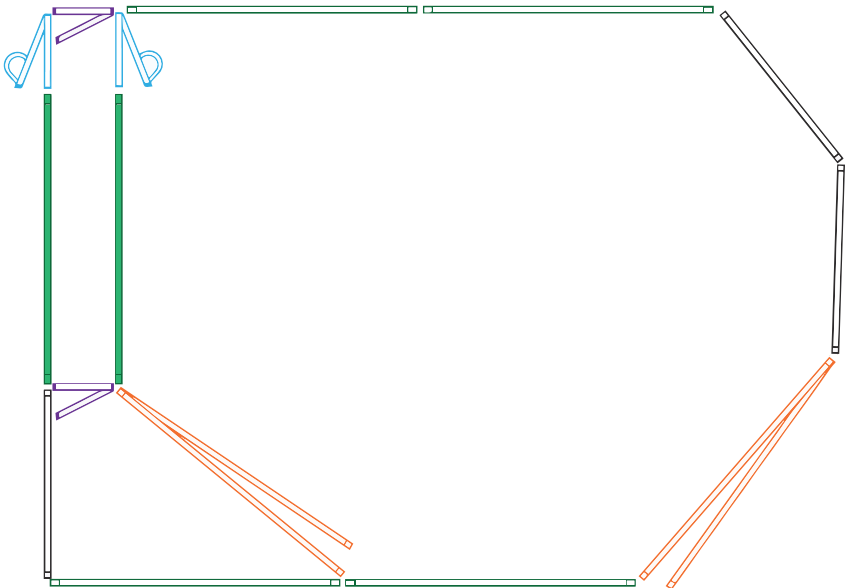

KIT INCLUDES:

Sheep Panel 3.0 Blind	■	2
Sheep Panel 3.0	□	4
Sheep Panel 2.0	■	3
Sheep Gate 3.0	■	2
Draft Gate	■	2
Race End Gate	■	2



Yard Plan for 60+ Sheep

KIT INCLUDES:

Sheep Panel 3.0		7
Sheep Gate 3.0		4
V-Race		1
Lift Up/Race Gate		1

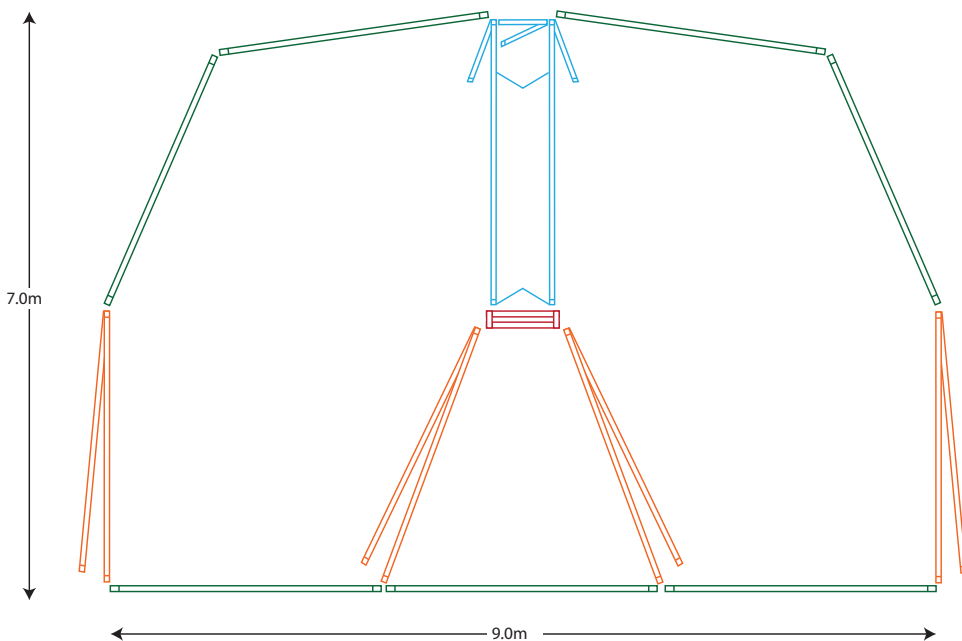



Yard Plan for 200+ Sheep





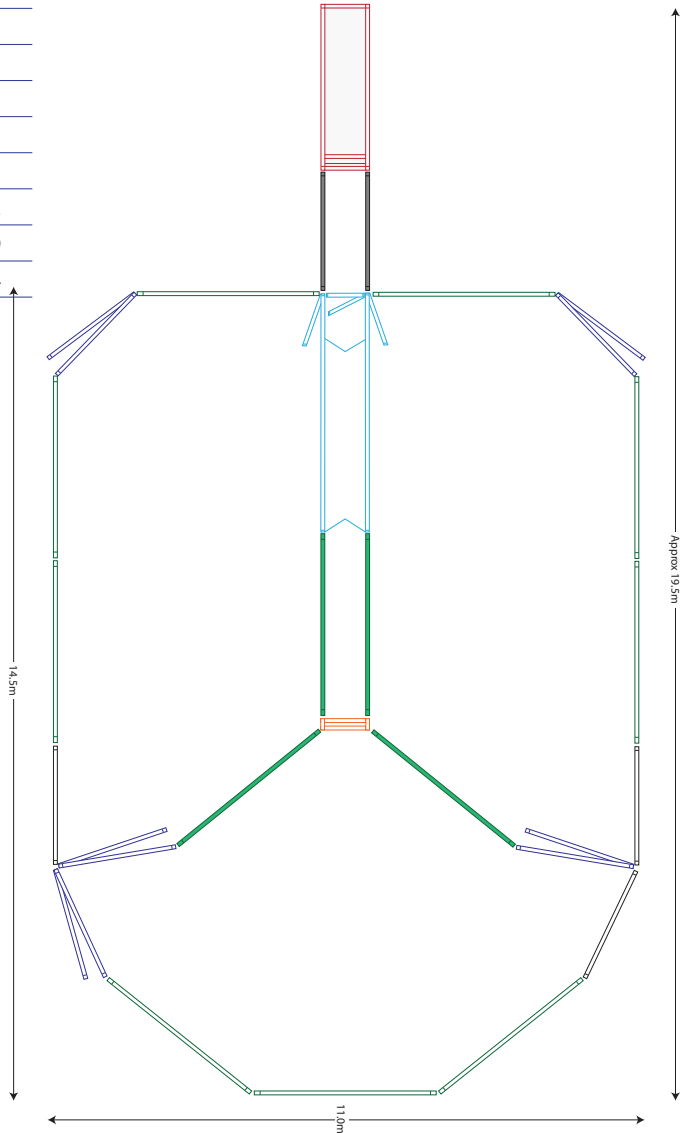



KIT INCLUDES:

Loading Ramp	■	1
Adjustable V-Race	■	1
Guillotine Gate	■	1
Sheep Gate 2.0	■	5
Sheep Panels 2.0	□	3
Sheep Panels 2.0 Blind	■	2
Sheep Panels 3.0	□	9
Sheep Panels 3.0 Blind	■	4



Yard Plan for 400+ Sheep

KIT INCLUDES



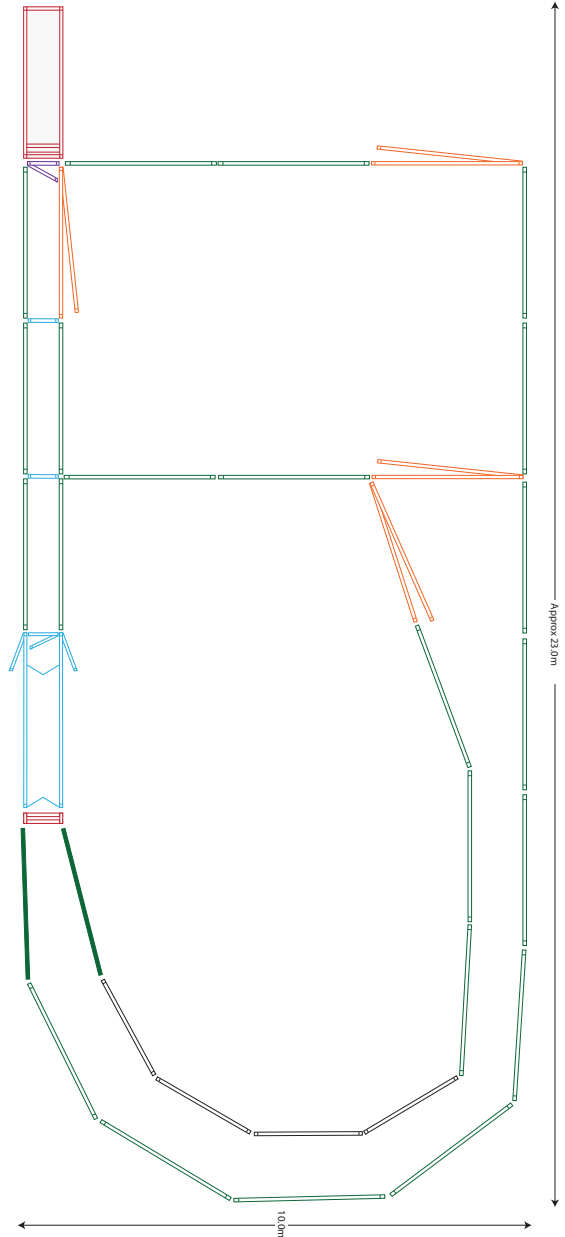







Sheep Panel 3.0		22
Sheep Panel 2.0		4
Sheep Panel Blind 3.0		2
Sheep Gate 3.0		4
V-Race		1
Loading Ramp		1
Race Bows		2
Race Gates		2





Yard Plan for 700 Sheep

KIT INCLUDES:



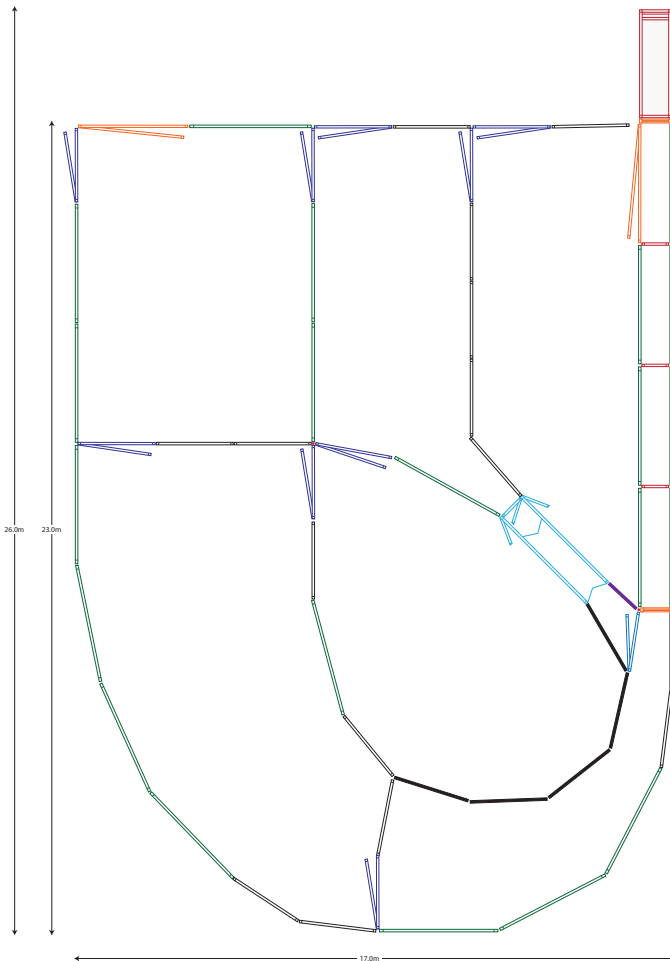





Loading Ramp		1
Adjustable V-Race		1
Guillotine Gate		2
Sheep Race Bow		3
Sheep Panels 1.0 Blind		1
Draft Gate		1
Sheep Gate 2.0		9
Sheep Panels 2.0		15
Sheep Panels 2.0 Blind		5
Sheep Gate 3.0		2
Sheep Panels 3.0		21





Yard Plan for 800+ Sheep

KIT INCLUDES:

Adjustable V-Race		1
Sheep Race Gate		1
Sheep Draft Gate		1
Sheep Race Bow		2
Sheep Panels 1.0		2
Sheep Panels 2.0		15
Sheep Panels 2.0 Blind		12
Sheep Gate 3.0		10
Sheep Panels 3.0		18

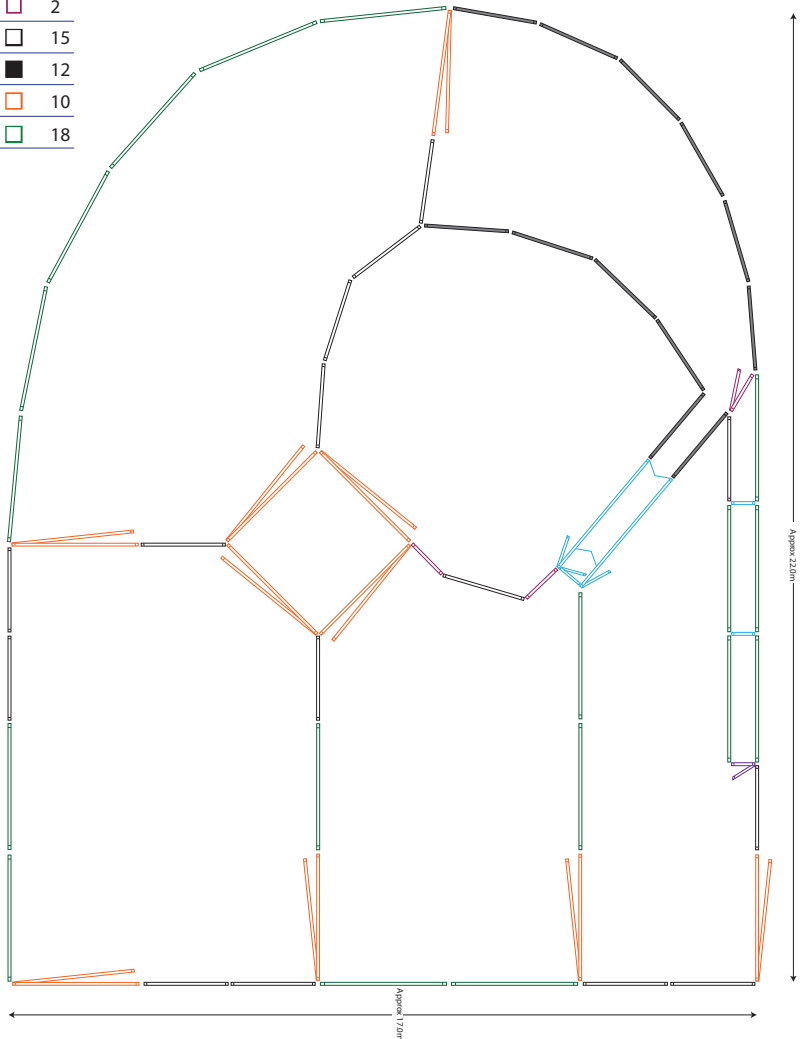



Yard Plan for 1000 Sheep

KIT INCLUDES:



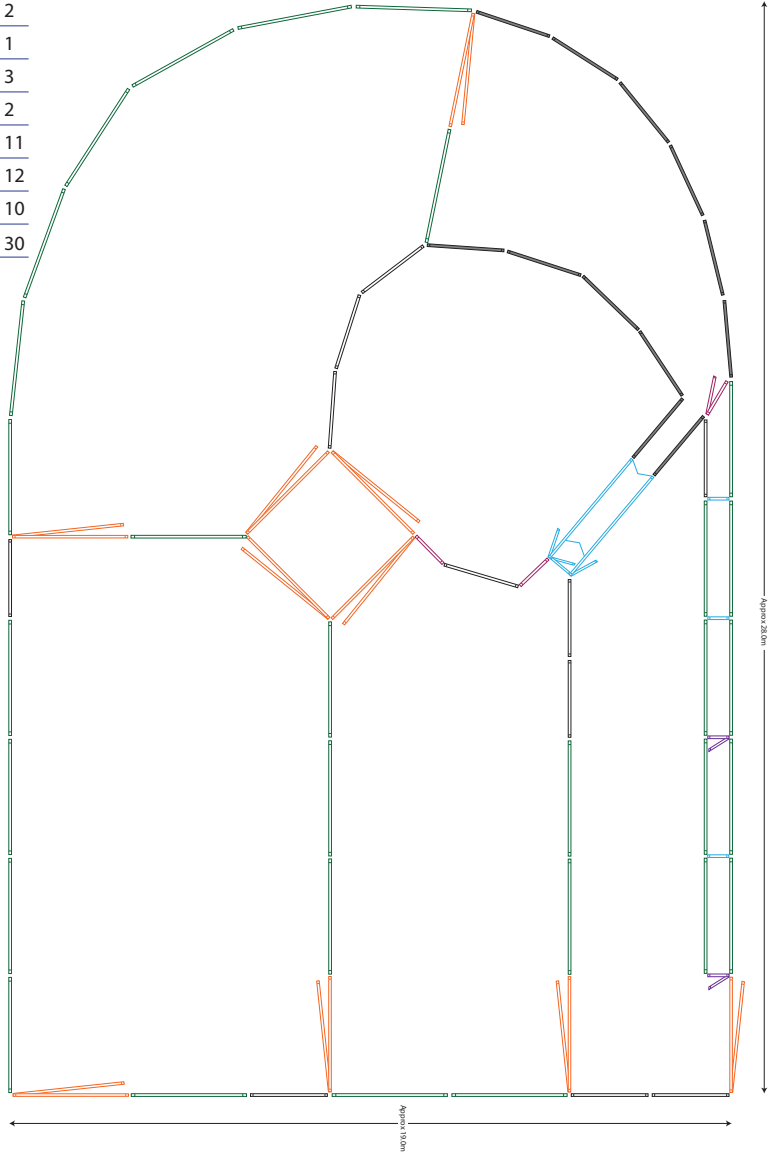







Adjustable V-Race	□	1
Sheep Race Gate	□	2
Sheep Draft Gate	□	1
Sheep Race Bow	□	3
Sheep Panels 1.0	□	2
Sheep Panels 2.0	□	11
Sheep Panels 2.0 Blind	■	12
Sheep Gate 3.0	□	10
Sheep Panels 3.0	□	30





Yard Plan for 1200 Sheep

KIT INCLUDES

Adjustable V Race		1
Sheep Panel 3.0		53
Sheep Panel 2.0		8
Blind Panel 3.0		6
Blind Panel 2.0		2
Sheep Gate 3.0		10
Sheep Gate 2.0		1
Sliding Sheep Gate		3
Sheep Race Bow		3
Man Panel Gate 3.0		2

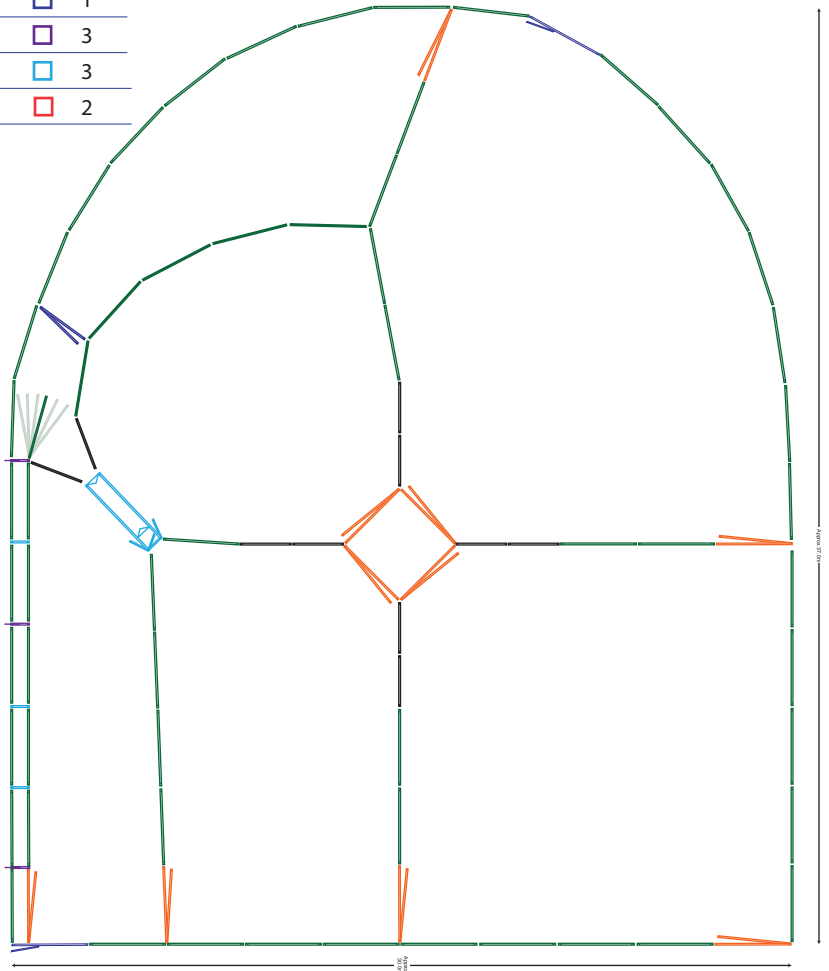



Round Yard 20m

KIT INCLUDES:

Standard Gate 2.1	■	1
Standard Panel 2.1	■	27

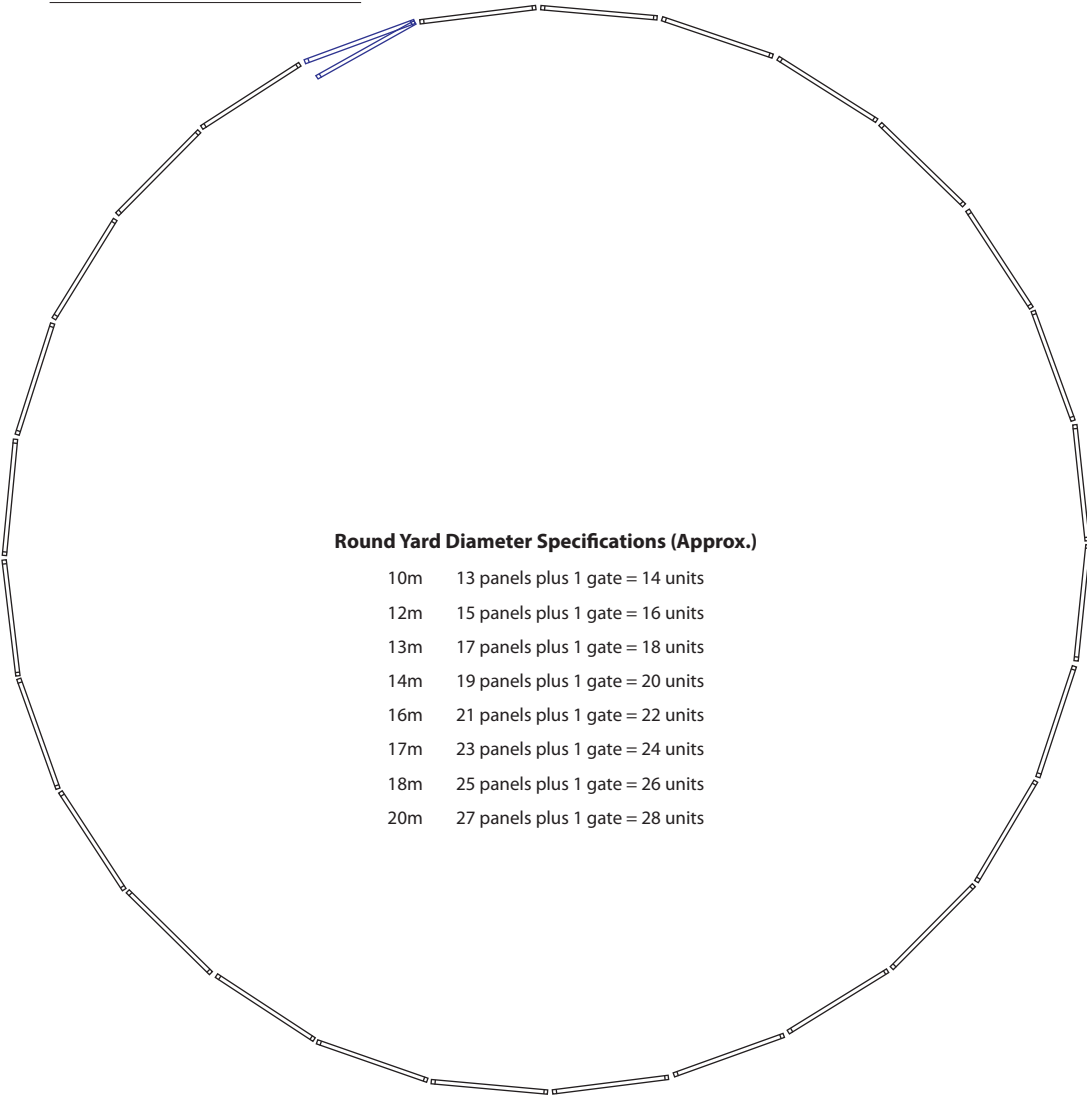

Round Yard Diameter Specifications (Approx.)

10m	13 panels plus 1 gate = 14 units
12m	15 panels plus 1 gate = 16 units
13m	17 panels plus 1 gate = 18 units
14m	19 panels plus 1 gate = 20 units
16m	21 panels plus 1 gate = 22 units
17m	23 panels plus 1 gate = 24 units
18m	25 panels plus 1 gate = 26 units
20m	27 panels plus 1 gate = 28 units

PREMIUM CRUSH

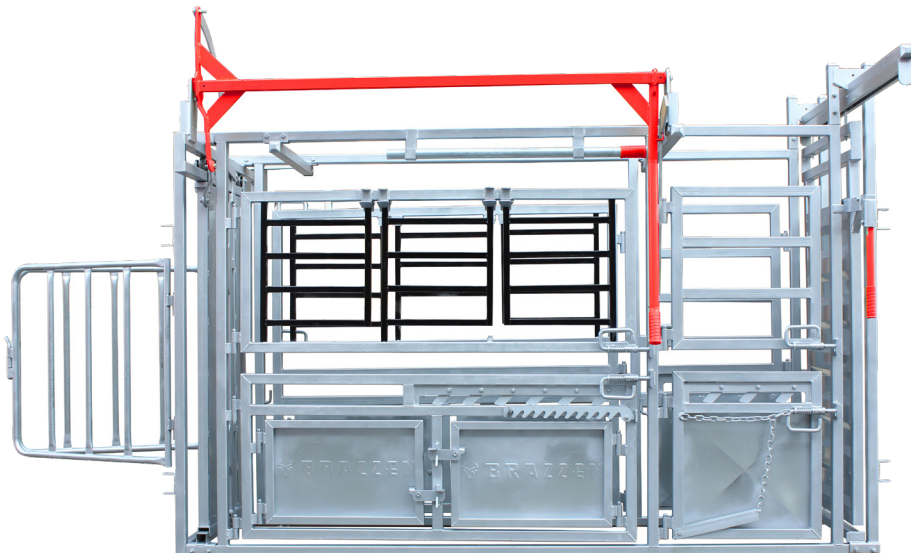

...let our products work for you!

- 3mm Gauge Steel Frame
- Walk Through Vet Section
- Bulk Gate
- Kick Latch
- Rump Squeeze
- New Design Allows Safer Access to Rear of Animal
- Triple Top Gates Allowing Full Access Along Animal
- Double Lower Doors on Each Side for Hoof Access
- Sheeted Sliding Gate
- Long Ratchet Rump Bar Mechanism
- Auto Lock Rear Sliding Gate
- Supplied in Flat Pack



		Length	Depth	Height	Weight
Premium Crush	CCFPF	3350(11')	850(2.79')	2030(7.5')	644kg(1420lb)



www.brazzen.com.au | 1300 686 517

FORCE YARD



Standard Force

- The force yard allows the handler to push cattle into the race system with minimal risk to the handler.
- Innovative braking system stops the cattle from pushing the gate back therefore protecting the operator.
- The curved layout works with the natural behaviour of how cattle run and tend to circle back to where they came from.

Offside Force

- When using an offside force yard and a standard crush, the force yard requires the walkway to allow operation from the outside in line with crush operation.

...let our products work for you!

		Width	Depth	Height	Weight
Blind	CFYB	6300(20.67')	3150(10.33')	2200(7.22')	622kg(1371lb)
Blind-Offside	CFYBO	6300(20.67')	3150(10.33')	2200(7.22')	622kg(1371lb)
Walkway Kits	CFYBWK				112kg(246lb)





YARD PLANS

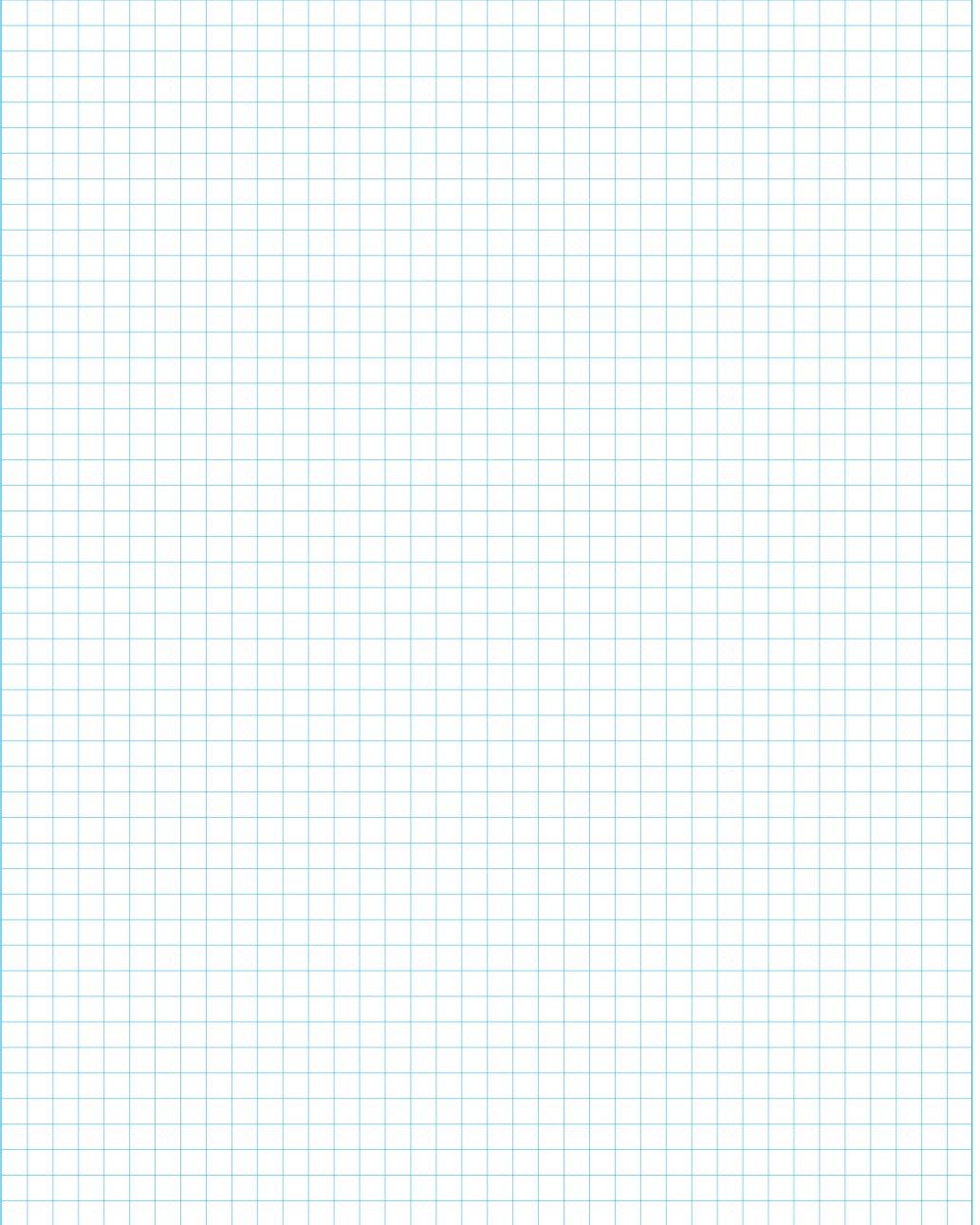



www.brazzen.com.au